

# GAS NATURAL INDUSTRIAL

## ( 1 ) FILTRO TIPO CAZOLETA ROSCADO PN-6 BAR

CODIGO	DESCRIPCION	PVR
FGMA00060015	FILTRO GAS MADAS ROSCADO PN 6 1/2"	27,95 €
FGMA00060020	FILTRO GAS MADAS ROSCADO PN 6 3/4"	27,95 €
FGMA00060025	FILTRO GAS MADAS ROSCADO PN 6 1"	27,95 €
FGMA00060032	FILTRO GAS MADAS ROSCADO PN 6 1 1/4"	47,39 €
FGMA00060040	FILTRO GAS MADAS ROSCADO PN 6 1 1/2"	47,39 €
FGMA00060050	FILTRO GAS MADAS ROSCADO PN 6 2"	57,11 €



## FILTRO TIPO CAZOLETA CON BRIDAS PN-6 BAR

CODIGO	DESCRIPCION	PVR
FGMA00061040	FILTRO GAS MADAS CON BRIDAS PN 6 DN 40	117,86 €
FGMA00061050	FILTRO GAS MADAS CON BRIDAS PN 6 DN 50	125,15 €
FGMA00061065	FILTRO GAS MADAS CON BRIDAS PN 6 DN 65	232,07 €
FGMA00061080	FILTRO GAS MADAS CON BRIDAS PN 6 DN 80	238,14 €
FGMA00061100	FILTRO GAS MADAS CON BRIDAS PN 6 DN 100	413,10 €
FGMA00061125	FILTRO GAS MADAS CON BRIDAS PN 6 DN 125	986,58 €
FGMA00061150	FILTRO GAS MADAS CON BRIDAS PN 6 DN 150	986,58 €
FGMA00061200	FILTRO GAS MADAS CON BRIDAS PN 6 DN 200	2.875,91 €
FGMA00061300	FILTRO GAS MADAS CON BRIDAS PN 6 DN 300	4.794,39 €

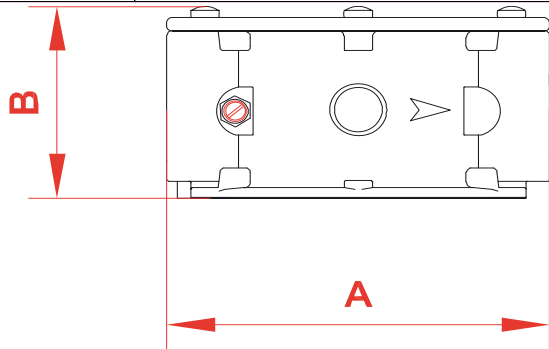

**Fig.1**

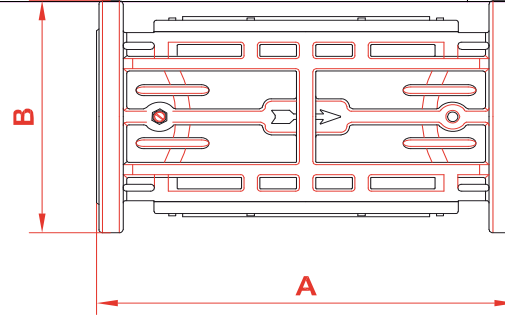

**Fig.2**

Conexión	A	B	Peso (Kg)	Superficie Filtrante (mm <sup>2</sup> )
<b>Fig. 1 (1/2")</b>	120	72	0,5	4560
<b>Fig. 1 (3/4")</b>	120	72	0,5	4560
<b>Fig. 1 (1")</b>	120	72	0,5	10650
<b>Fig. 1 (1 1/4")</b>	160	87	1,25	10650
<b>Fig. 1 (1 1/2")</b>	160	87	1,2	10650
<b>Fig. 1 (2")</b>	160	110	1,2	10650
<hr/>				
<b>Fig. 2 DN-40</b>	230	150	1,35	10650
<b>Fig. 2 DN-50</b>	<b>230</b>	<b>150</b>	1,35	10650
<b>Fig. 2 DN-65</b>	290	180	1,35	39240
<b>Fig. 2 DN-80</b>	310	195	5,3	39240
<b>Fig. 2 DN-100</b>	350	211	5,7	76250
<b>Fig. 2 DN-125</b>	480	302	15	198000
<b>Fig. 2 DN-150</b>	480	302	25	198000
<b>Fig. 2 DN-200</b>	600	380	26,2	-
<b>Fig. 2 DN-300</b>	737	510	90	-

**MADAS**<sup>®</sup>



Homologación CE según EN 126

Filtración: 50 µm

**RESITE** *gas*

TEL. 916418495  
FAX. 916448498  
INFO@RESITE.ES

C/ NAVALES, 51  
POL. IND. URTINSA I  
ALCORCÓN - 28923  
MADRID

**03/01/2019**





Pagina: **150**

Familia: **GN14**

Validez mes en curso

# GAS NATURAL INDUSTRIAL

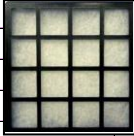
## CARTUCHOS FILTRANTES MADAS

CODIGO	DESCRIPCIÓN			PVR
FMC020000	CARTUCHO FILTRANTE DE 50 MICRAS	54X72X8	FMCCOMPACT <b>DN15</b> ROSCADO	18,00 €
FMC030000	CARTUCHO FILTRANTE DE 50 MICRAS	54X72X8	FMCCOMPACT <b>DN20</b> ROSCADO	18,00 €
FMC040000	CARTUCHO FILTRANTE DE 50 MICRAS	54X72X8	FMCCOMPACT <b>DN25</b> ROSCADO	18,00 €
				
FM020000	CARTUCHO FILTRANTE DE 50 MICRAS	40X114X8	FM <b>DN15</b> ROSCADO	20,00 €
FM030000	CARTUCHO FILTRANTE DE 50 MICRAS	40X114X8	FM <b>DN20</b> ROSCADO	20,00 €
FM040000	CARTUCHO FILTRANTE DE 50 MICRAS	40X114X8	FM <b>DN25</b> ROSCADO	25,00 €
				
FM04M0000	CARTUCHO FILTRANTE DE 50 MICRAS	<b>59X241</b>	FM <b>DN25M</b> ROSCADO	30,00 €
FM050000	CARTUCHO FILTRANTE DE 50 MICRAS	<b>59X241</b>	FM <b>DN32</b> ROSCADO	35,00 €
FM060000	CARTUCHO FILTRANTE DE 50 MICRAS	<b>59X241</b>	FM <b>DN40</b> ROSCADO	40,00 €
FM500000	CARTUCHO FILTRANTE DE 50 MICRAS	<b>91X228</b>	FM <b>DN50</b> ROSCADO	45,00 €
				
FGM25M0000	CARTUCHO FILTRANTE DE 50 MICRAS	105X105X35	FGM <b>DN25M</b> BRIDADO	30,00 €
FF320000	CARTUCHO FILTRANTE DE 50 MICRAS	105X105X35	FGM <b>DN32</b> BRIDADO	30,00 €
FF400000	CARTUCHO FILTRANTE DE 50 MICRAS	105X105X35	FGM <b>DN40</b> BRIDADO	55,00 €
FF500000	CARTUCHO FILTRANTE DE 50 MICRAS	105X105X35	FGM <b>DN50</b> BRIDADO	55,00 €
				
<b>Hasta 03/2009</b>				
FF080000	CARTUCHO FILTRANTE DE 50 MICRAS	210X363X15	FM <b>DN65</b> BRIDADO	110,00 €
FF090000	CARTUCHO FILTRANTE DE 50 MICRAS	210X363X15	FM <b>DN80</b> BRIDADO	110,00 €
<b>desde 03/2009</b>				
FF080000	CARTUCHO FILTRANTE DE 50 MICRAS	109x360x15	FM <b>DN65</b> BRIDADO	55,00 €
FF090000	CARTUCHO FILTRANTE DE 50 MICRAS	109x360x15	FM <b>DN80</b> BRIDADO	55,00 €
				
<b>Hasta 06/2002</b>				
FF100000	CARTUCHO FILTRANTE DE 20 MICRAS	330x180	FM <b>DN100</b> BRIDADO	125,00 €
<b>Desde 06/2002</b>				
FF100000	CARTUCHO FILTRANTE DE 50 MICRAS	151X505	FM <b>DN100</b> BRIDADO	60,00 €
<b>Hasta 05/2013</b>				
FF110000	CARTUCHO FILTRANTE DE 10 MICRAS	Ø 232 h 257	FM <b>DN125</b> BRIDADO	372,00 €
FF120000	CARTUCHO FILTRANTE DE 10 MICRAS	Ø 232 h 257	FM <b>DN150</b> BRIDADO	372,00 €
<b>Desde 06/2013</b>				
FF110000	CARTUCHO FILTRANTE DE 10 MICRAS	Ø 240 h 275	FM <b>DN125</b> BRIDADO	408,00 €
FF120000	CARTUCHO FILTRANTE DE 10 MICRAS	Ø 240 h 275	FM <b>DN150</b> BRIDADO	408,00 €
				
FF130000	CARTUCHO FILTRANTE DE 10 MICRAS	Ø 292 h 299	FM <b>DN200</b> BRIDADO	740,00 €
FF140000	CARTUCHO FILTRANTE DE 10 MICRAS	Ø344 h382	FM <b>DN250</b> BRIDADO	796,00 €
FF150000	CARTUCHO FILTRANTE DE 10 MICRAS	Ø362 h439	FM <b>DN300</b> BRIDADO	1.072,00 €

**RESITE** *gas*

TEL. 916418495  
FAX. 916448498  
INFO@RESITE.ES

C/ NAVALES, 51  
POL. IND. URTINSA I  
ALCORCÓN - 28923  
MADRID

**03/01/2019**

Página: **153**

Familia: **GNI4**

Validez mes en curso